

Product Name	Copper Liquid Gold Plate
Model number	HS-SC80-170
Inquiry phone number	Osaka CMB Sales office +81-6-6532-1301 Kawaso Texcel Corporation

Products will be shipped after making tap holes and through holes according to your required mounting positions. Please inform us of your requirements.

ver. 1.0.1

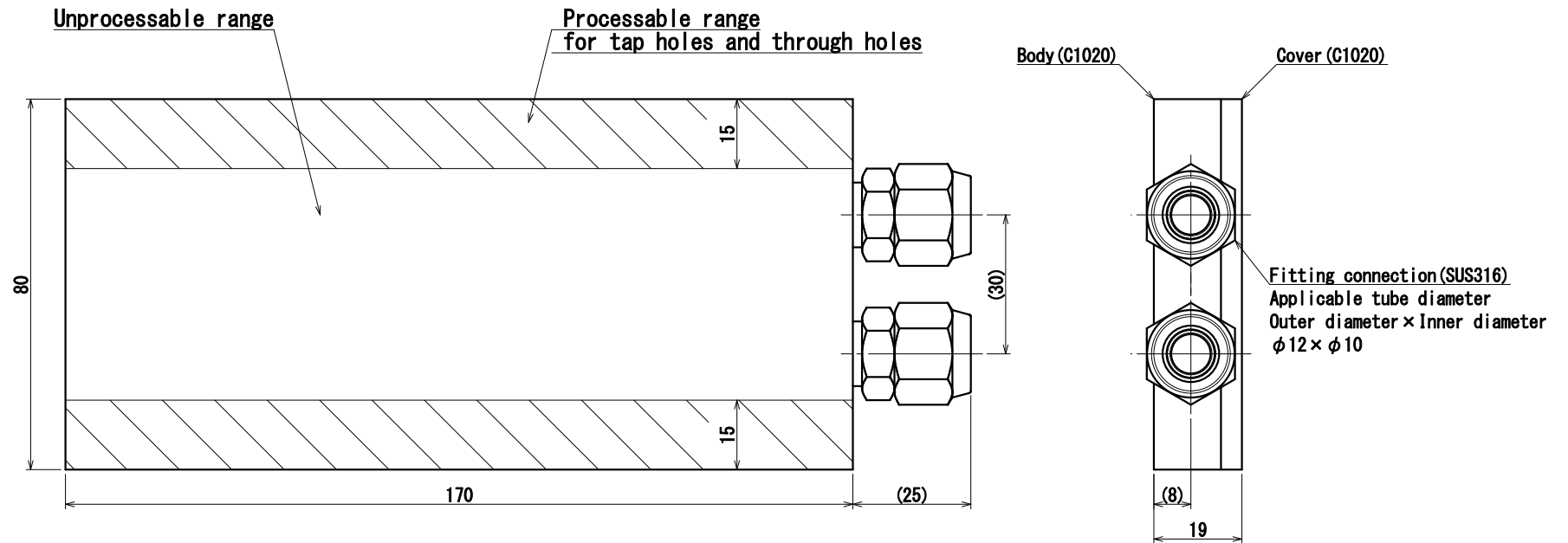

Weight : about 2.0kg

### Specifications

- ※There are processing marks on the cooling surface.
- ※In order to ensure heat sink performance, surface flatness and parallelism of the product is set to 0.02 mm or less.
- ※Commercial bolts (JIS B 0209-1 fitting classification: middle) pass through the threaded section.
- ※There is a step (about 0.5 to 1.0 mm) at the joint between the body and the cover.  
However, the cover does not go outward from the body.
- ※Performed matt Ni plating (2 μm) on the whole as base plating.  
When machining inside the tapped holes, inside the holes may be non-plated.

### Handling Precautions

- ※Pure water or antifreeze containing corrosion inhibitor is recommended for coolant.
- ※Even when pure water is used, it is recommended to install an ion exchange unit to prevent ion concentration increase in circulating water.
- ※Because city water and industrial water may corrode copper, please refrain from using.
- ※When attaching the tube to the fitting connection, please fix it with a tool so that no force is applied to the joint between the fitting connection and copper.
- ※Please note that dimensions and specifications may be changed without prior notice.